

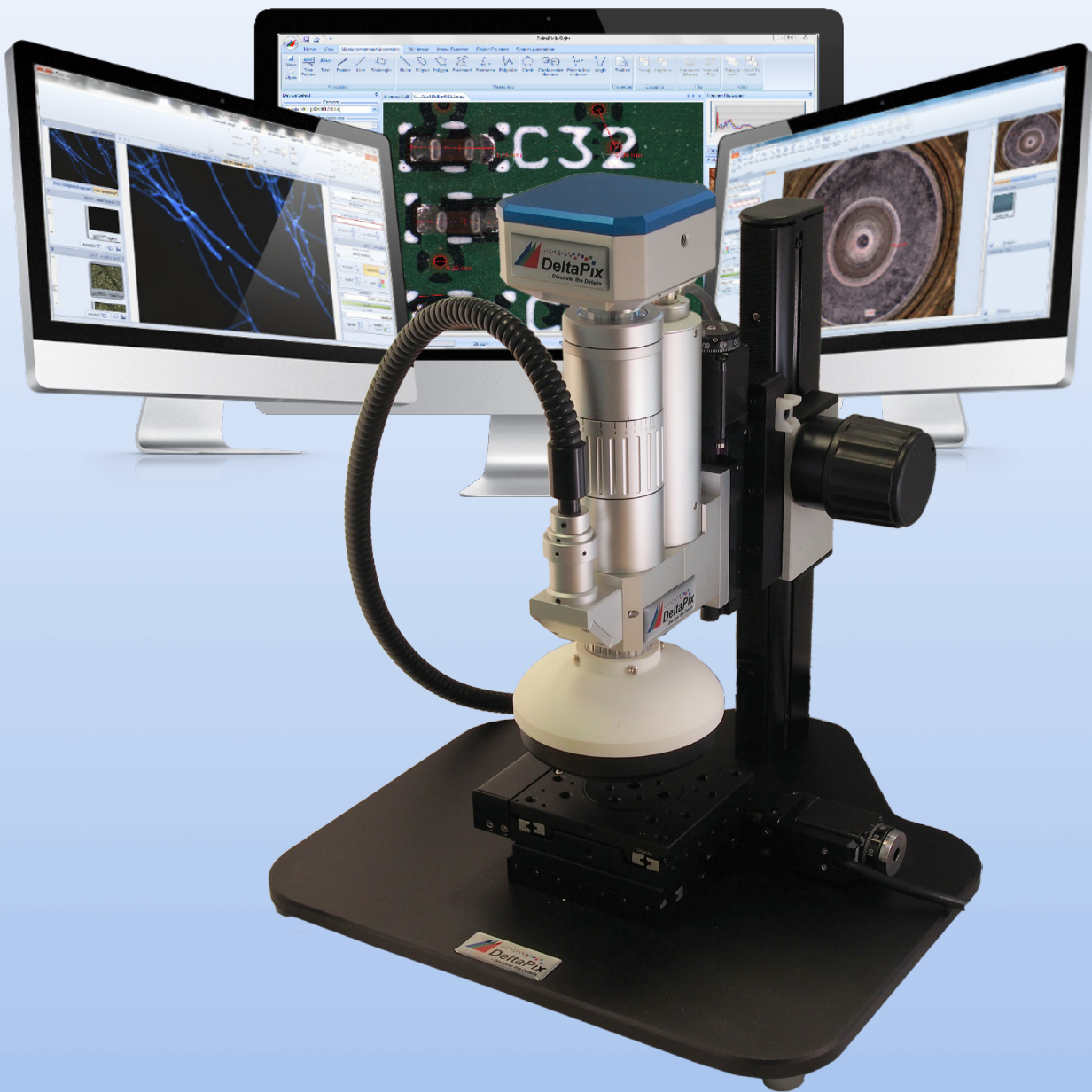

DeltaPix Modus M12Z Digital microscope



DeltaPix Modus 12Z Compact Full

This innovative fully motorized and automated digital microscope offers quality and features never seen before at this price level. "Super depth of field", "Auto stitching", Automatic scanning, 3D topography; everything is included in an ultra compact and affordable system.

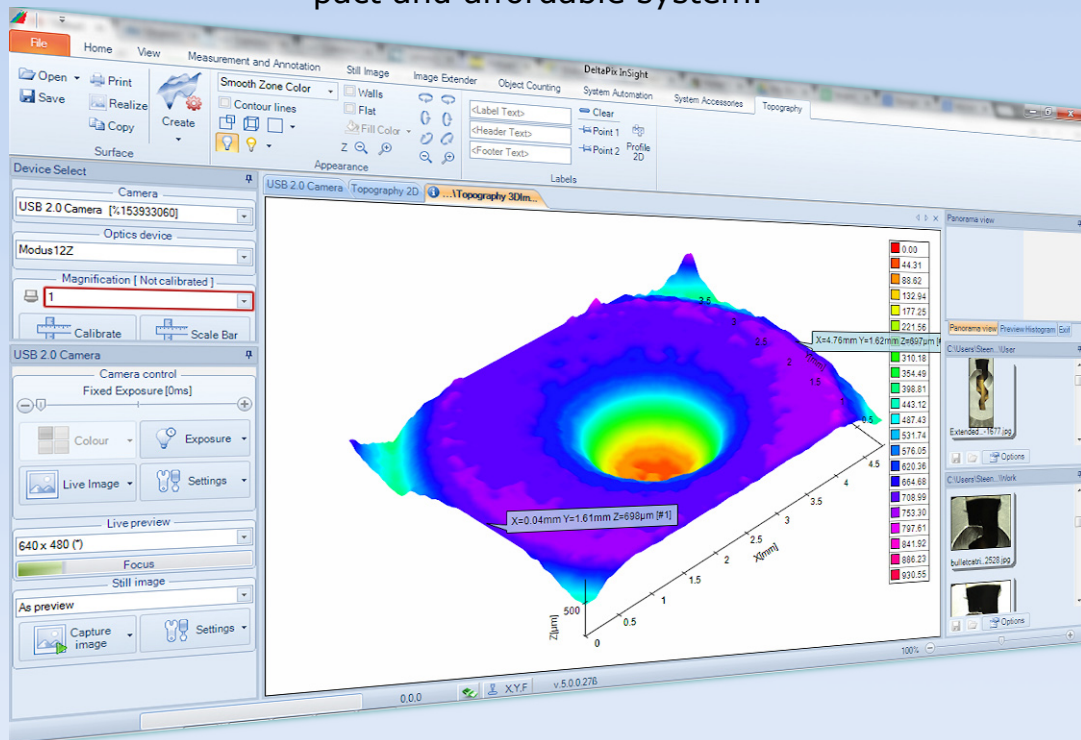

The ultimate digital microscope-console

The Modus 12Z is designed with the user's comfort in focus, advanced functions as Zoom, focus, image capture, XY position can all be controlled ergonomically with a joystick. Providing comfort and improved working posture thus preventing health issues due to physical strain. Calibration in all directions is automatically updated by the DeltaPix InSight software.

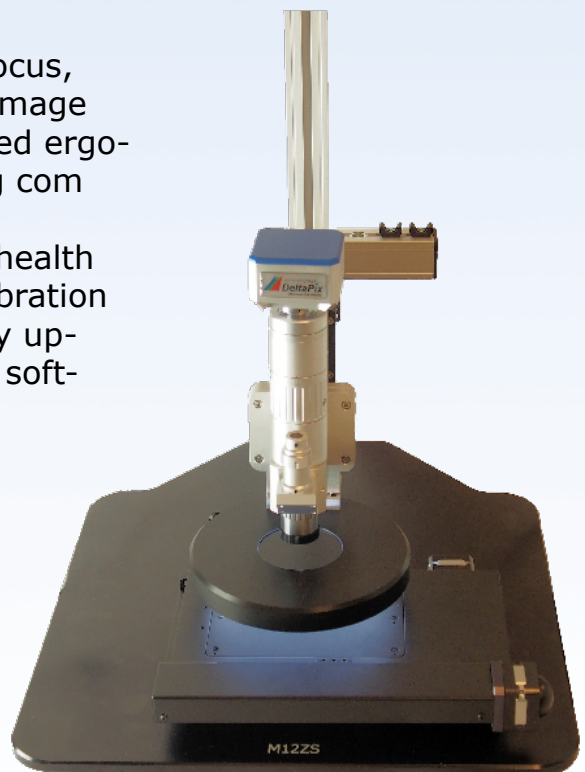

Super Depth of Field

Modus 12Z has the ability to produce "Super depth of field", by capturing images at different focal planes and intelligently extracting a full focus image from the captured images. The number of images needed for each extended focus capture, can be automatically calculated from the depth of focus at that actual magnification.

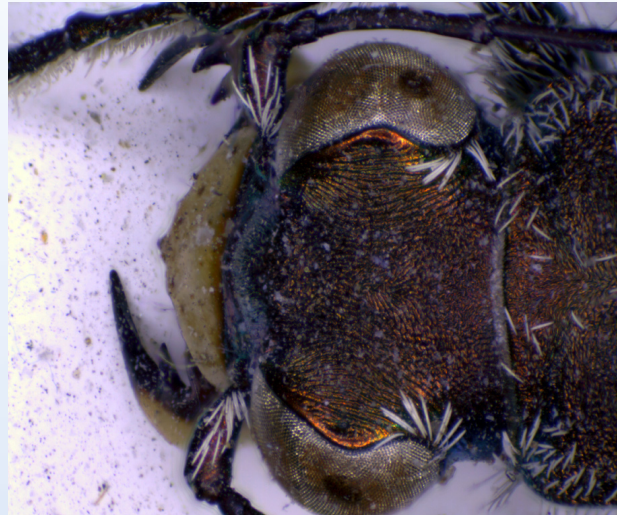
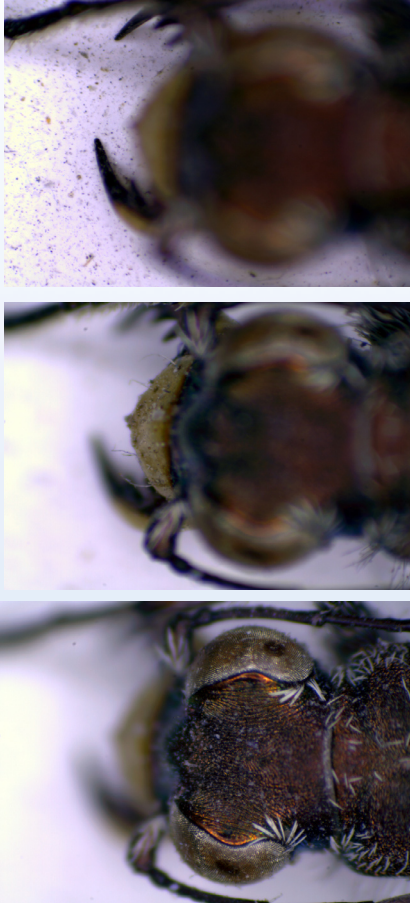

Stunning High Resolution Optics

The Modus 12Z, is built around a 12 times Zoom system made in Japan. As it is a mono system, the optics can be made much smaller, more economical and more compact, compared to a similar stereo zoom system. The optical quality is comparable or even better than the best stereo microscopes.

To avoid vibrations during image capture, at high magnifications, the mechanical system and the optics are assembled from extremely solid, yet very compact components.

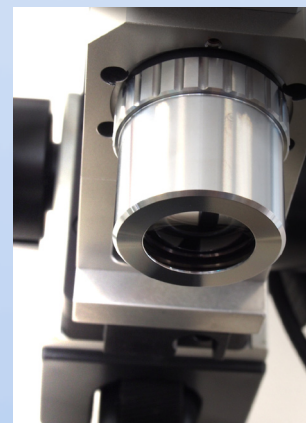

Extended Field of View / Auto stitching

By including a motorized XY stage with the Modus 12Z microscope, the field of view can be extended significantly. This is done without involving the user in complicated calculations, the user just moves the specimen in real time with the joystick or keyboard to two opposite corners of the area of interest, then the software does the rest by itself. The resulting image combines the overview enabled by a large field of view with unmatched microscopic details. The automatic stitching can be combined with extended depth of field, extended image dynamics and auto focus.

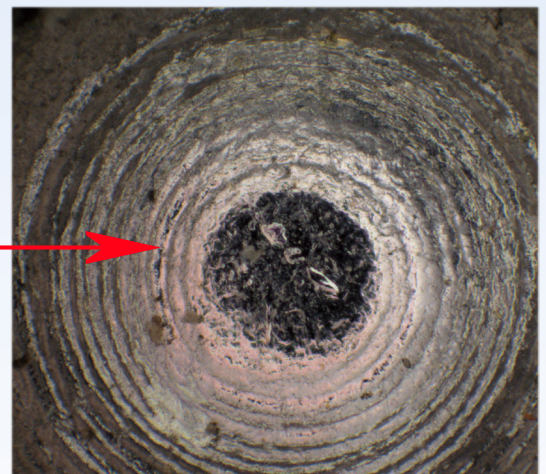
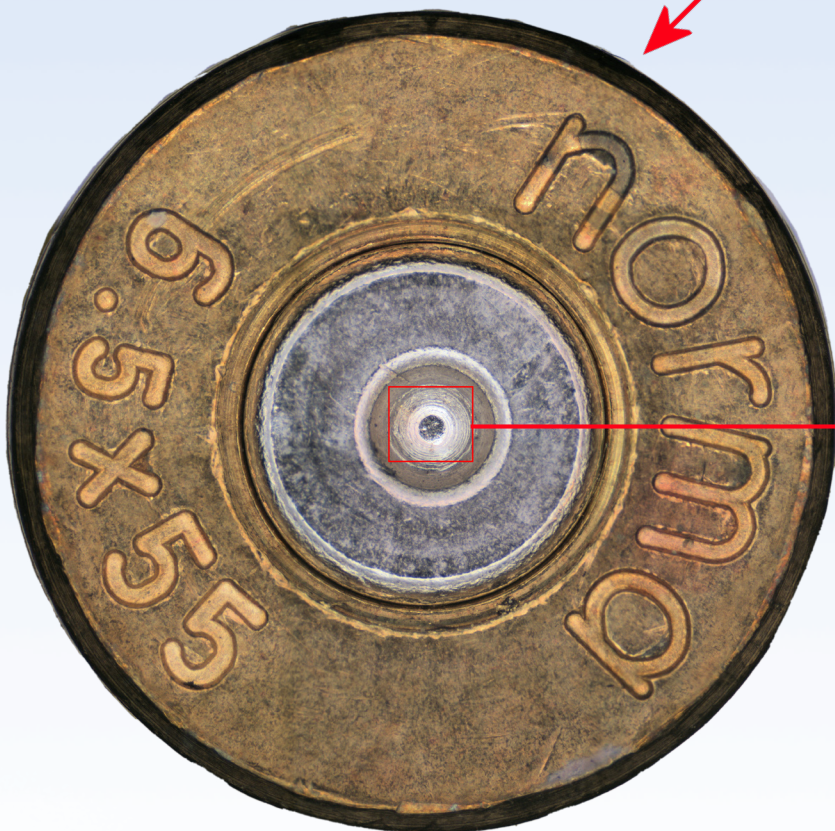
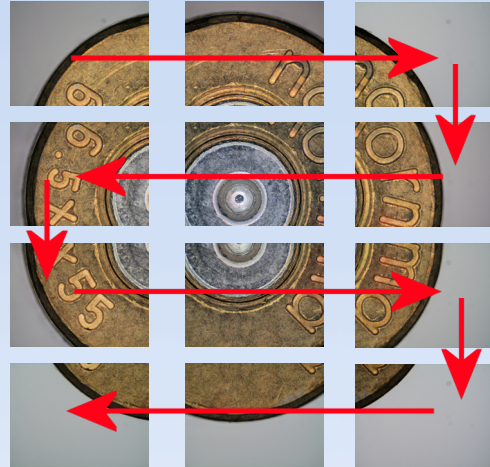
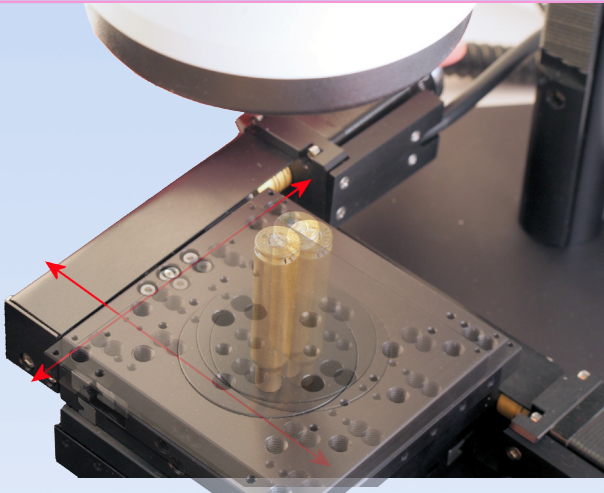

The large stitched images include microscopic details from the individual input images.

3D Topography

With the 3D module in InSight, it is possible to display the topography of the specimen under observation. Height measurements and profiles across any section of the material can be displayed and documented. As dark and saturated parts will make the results less reliable, the Modus 12Z uses the innovative dome light and extended dynamics to achieve reliable results, which cannot be achieved in other similar systems.

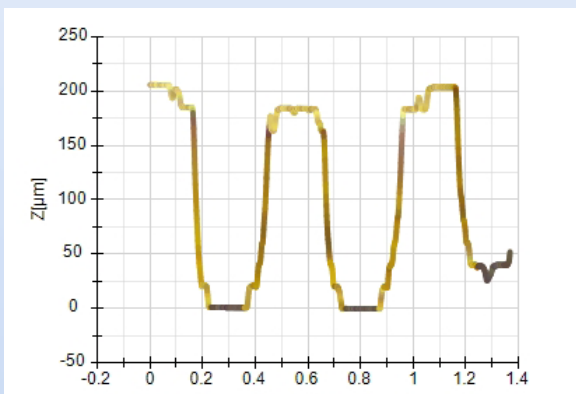
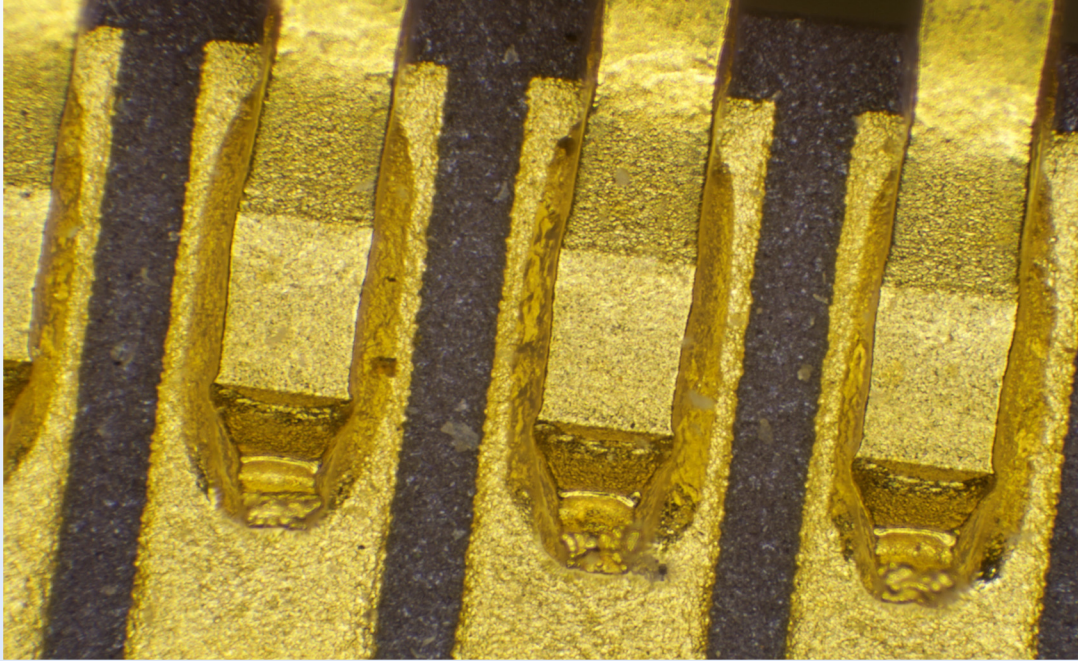

A 2D profile can be calculated between any two points on the surface.

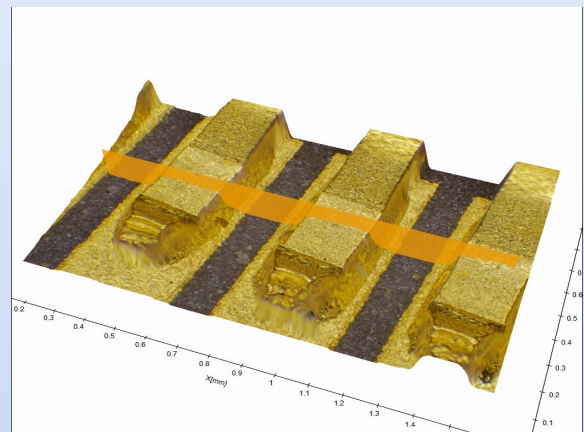

3D topography of a chip pins on a PCB board.

Motorized Zoom

Modus 12Z includes a motorized zoom monoscope of the highest mechanical and optical quality. With motorized zoom in combination with motorized focus and XY-table, there is no need for manual interaction with the microscope, which enables the possibility of exploring sensitive specimens, even in an isolated chamber.

Measurements will always be precise due to the accurate software controlled positioning of mechanical zoom position. Besides smooth zooming in and out, fixed zooming positions can be defined, as if the microscope had separate objectives.

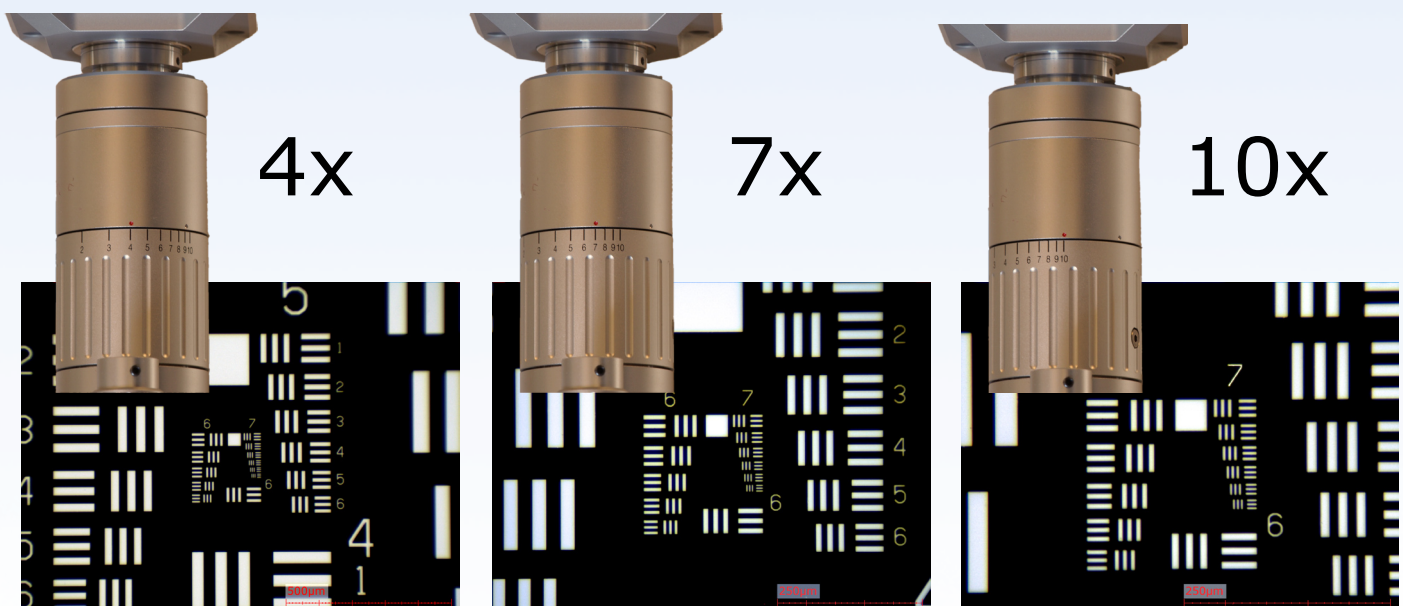
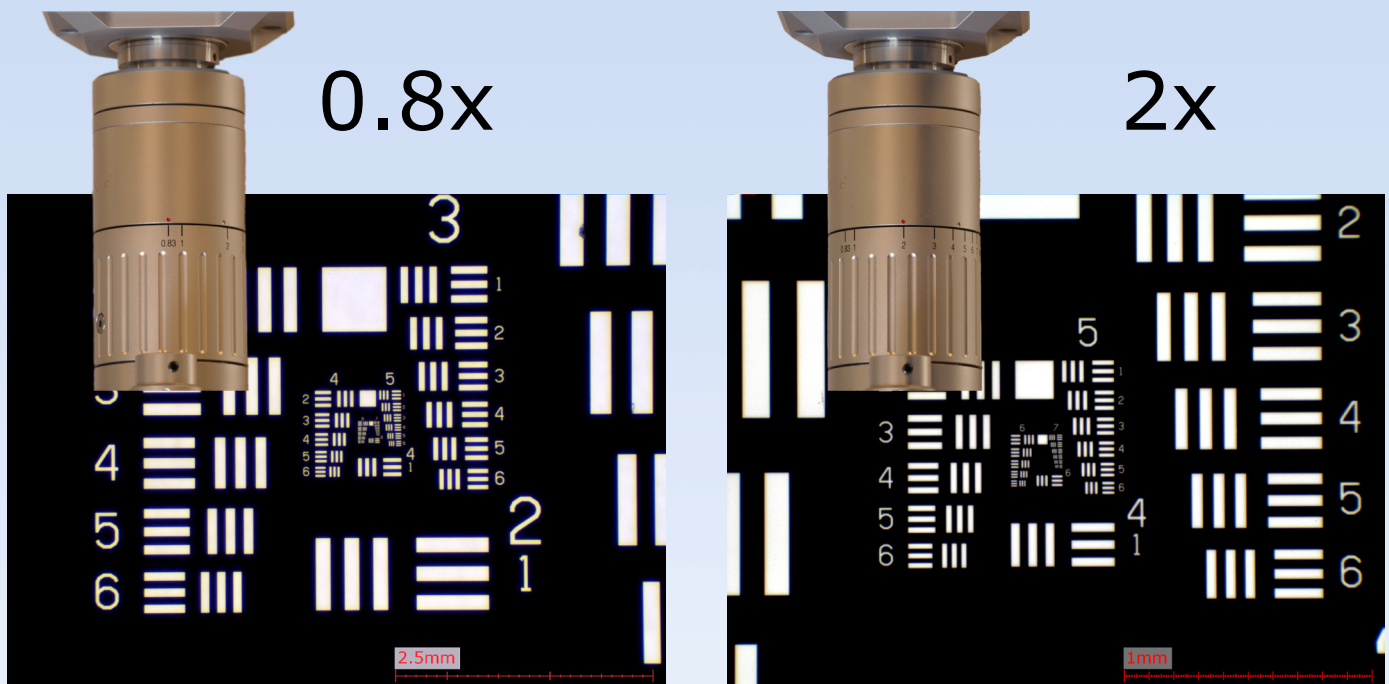

Innovative light source options

Modus 12Z includes three integrated light source options, Epi-coaxial light, ring light and dome light. Epi-coaxial light is perfect for flat surfaces, dome light is perfect for shiny specimens with topography and ring light for many non reflective specimens with significant topography. For reliable topography results, the dome light is the most ideal, as both reflections and dark areas can cause faulty results.

Coax light

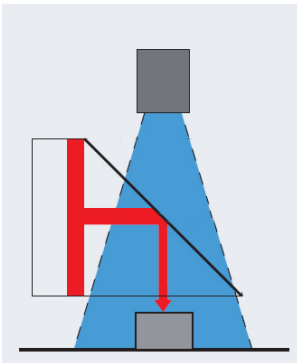

Dome light

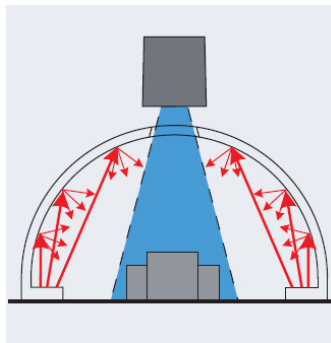

Ring light

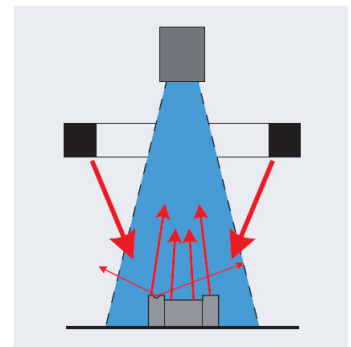

Coin surface



Cast iron surface

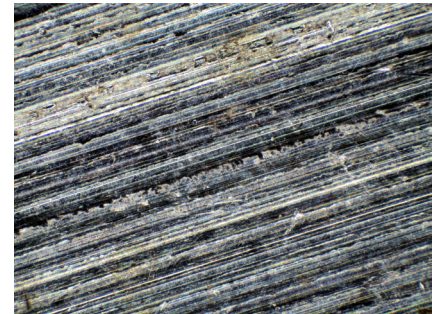
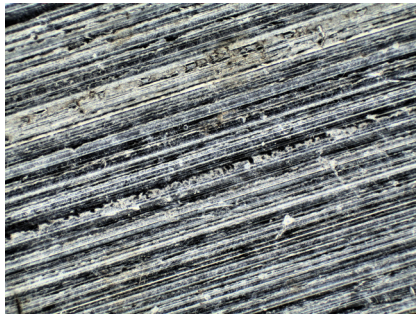
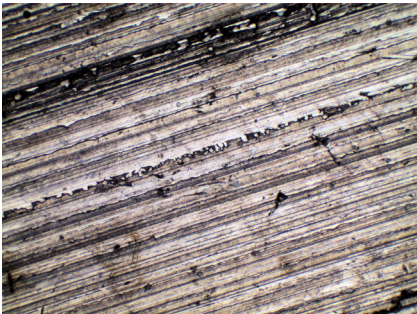

Individual build systems

The DeltaPix Modus 12Z can be configured to fit the needs of the user, so the performance / cost ratio can be optimized. The system can be built from a number of standard components, but most mechanical components can be custom designed for special needs.

Contact DeltaPix in case the standard components does not match your needs.

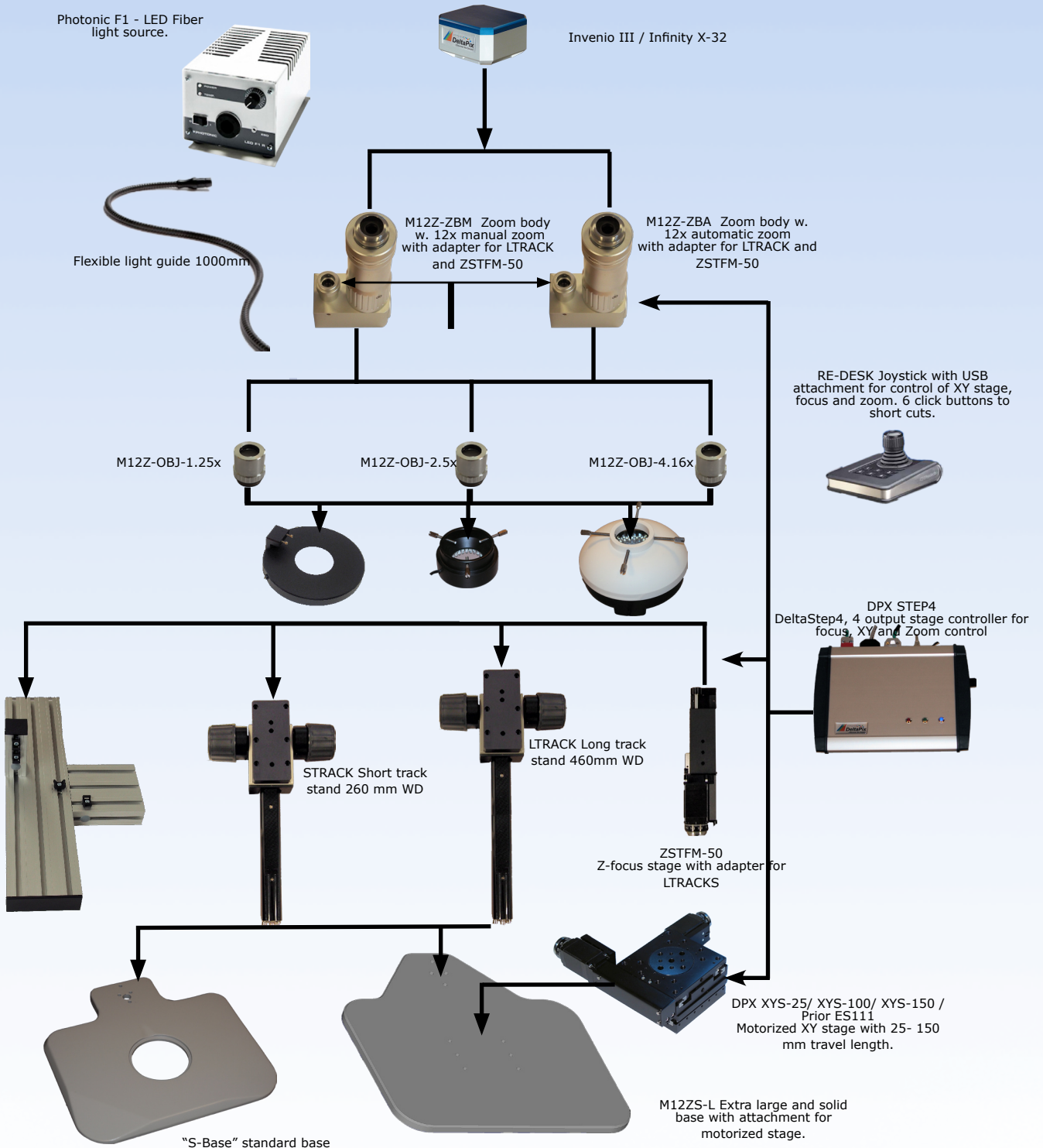

Specifications

Optics				
Version		M12Z-1.25	M12Z-2.5	M12Z-4.16
	Function			
	NA range	0.03-0.2	0.06-0.36	0.1-0.45
	Resolution	<1.5-11 μ m	<0.9-5.5 μ m	<0.7-3.4 μ m
	Focal depth	7-300 μ m	2-77 μ m	1.4-27 μ m
	Working Distance	46.2mm	35.25mm	14mm
Invenio 6EIII	Magnification* ¹	83-1560x	166-3120x	305-5740x
	Field of view* ²	7.2mm - 384 μ m	3.6mm - 192 μ m	2mm - 208 μ m
Infinity X-32	Magnification* ¹	83-4000x	166-8000x	305-14700x
	Field of view* ²	7.2mm - 150 μ m	3.6mm - 75 μ m	3.6mm - 41 μ m
Invenio 5SIII	Magnification* ¹	104-1940x	208-3880x	382-7140x
	Field of view* ²	5.7mm - 306 μ m	2.8mm - 153 μ m	1.5mm - 83 μ m
	Motorized Fine Focus range		50mm	
Focus-stage				
Version		STrack	LTrack	Track 8015
	Useable travel range	150mm	260mm	
	Height	260	460mm	500mm
XY-stage				
Version		DPX XYS-25 /SF	ES-111	DPX XYS-100/150
	Travel range x [mm]	25	125	100/150
	Travel range y [mm]	25	75	100/150
	Max speed [mm/s]	12/2.5	8	5
	Min step size [μ m]	0.6/0.125	0.2	0.31
	Repeatable precision [μ m]	10/1	5	2
	Load capacity, vertical [kg]	30	5	8
	Dimension [mm]	167x167	340x230	210/324x210/324
Base plates				
Version		S-Base	M12ZS-L	MZ12BASE-L
	Size [mm]		316x326	466x476
	Adaption for Motorized stages	no	Yes	Yes
DPX-STEP4 Controller				
Weight	Size	Output number	Power inlet	Control
500g	200x150x30mm	4x Stepper output	12V / 4A	Power on/off
*1: Maximum magnification and minimum FOV is calculated on a 24' monitor with 1600x1200 pixels, at 100% zoom at maximum still image camera resolution (one pixel on the sensor equals one pixel on the monitor, no "digital zoom interpolation"). FOV is diagonal.				

Your DeltaPix contact: